

POOL FROG® 6100 Instruction Manual

Mineral Pool-Care Cyclor for Pools up to 25,000 Gallons



Cleaner

because it kills bacteria two ways

Clearer

because it helps keep pH in range

Softer

because it reduces chlorine use up to 50%*

Easier

with pre-filled pacs for no mess,
no guess and no stress

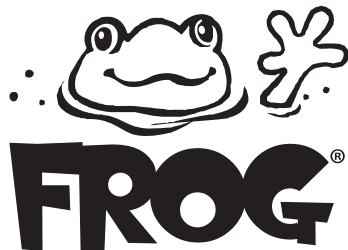

**POOL FROG Cyclor comes with the
POOL FROG Mineral Reservoir**
Patented Mineral Disinfectant

Customer Service 800-222-0169
frogproducts.com



WARNING

To minimize the risk of serious injury, death or damage, before installing or first using this equipment, read Instruction Manual and all safety labels and follow all safety instructions and precautions. Save manual for future reference.

TABLE OF CONTENTS

POOL FROG Introduction	3
Notes and Safety Information	4
Safety Labels on Cyclor	5
Installation Tips to Ensure Proper Performance	6
Filter Flex-Hose Installation	7
Base Flex-Hose Installation	8
Hard-Plumbed Installation	9
Step 1: Preparing the Pool	10-11
Step 2: Putting the System to Work	12
Step 3: Setting the Control Dial	13
Step 4: Routine Pool Care	14
Replacing POOL FROG Mineral Reservoir	15
Using FROG BAM[®]	16
Using POOL FROG Bac Pac[®]	17
Winterizing	18
Troubleshooting	19
Parts List	20
Maintenance - Replacing Control Dial O-Rings	21
Maintenance - Replacing Cap O-Rings and Knobs	22
Warranty	23

For information on King Technology's entire product line, visit our website at frogproducts.com

Welcome to easier pool care courtesy of FROG®. With POOL FROG, your pool water will look and feel better without a lot of work or a lot of chlorine. This system† controls bacteria using a combination of minerals and reduced chlorine levels—up to 50%* less.

There are 4 parts to the POOL FROG System:

1. Model 6100 POOL FROG Cyclor
2. POOL FROG Mineral Reservoir
3. FROG BAM 90-day Algae Preventative
4. POOL FROG Bac Pac

Part 1
POOL FROG Cyclor

The water treatment center that controls the flow of water to each part of the POOL FROG System.



For Pools up to 25,000 gallons.
Product # 01-01-6180

Part 2
POOL FROG Mineral Reservoir

Holds the minerals and fits inside the POOL FROG Cyclor.
Product # 01-12-6112



THE POOL FROG MINERAL RESERVOIR MUST BE REPLACED EVERY SIX MONTHS OR AFTER ONE POOL SEASON WHICHEVER IS SHORTER.

Part 3
FROG BAM

Use with the POOL FROG Cyclor for a 90-Day Algae-Protection Guarantee. One bottle is good for 15,000 gallons.
Product # 01-10-5060



Part 4
POOL FROG Bac Pac

Pre-filled with chlorine tablets and fits inside the POOL FROG Mineral Reservoir.
Product # 01-03-5880



POOL FROG Mineral Reservoir comes inside POOL FROG Cyclor and is also sold separately.
POOL FROG Bac Pac and FROG BAM also sold separately.

†FROG Mineral System consists of the FROG minerals silver chloride and carbonate used in conjunction with 0.5 ppm chlorine. The FROG Mineral Reservoir must be used in conjunction with the FROG Bac Pac (EPA Reg. No.: 53735-2), an EPA registered chlorine pool product or a chlorine delivery device.

*Compared to the minimum EPA recommended chlorine level of 1.0 ppm for a stabilized swimming pool.

Notes and Safety Information

General Notes

These instructions contain information for the safe and proper operation of this Cyclor. Observe the following principles:

- Ensure that everyone using this Cyclor follows the instructions and safety precautions.
- Keep the instructions nearby and available for reference throughout the service life of this Cyclor.

These instructions do not provide for every possible contingency that might be encountered in connection with installation, operation or maintenance of this equipment. Should further information be desired or should particular issues arise which are not covered sufficiently in this manual, contact King Technology at 800-222-0169.





Explanation of the signal words

Signal words, which depict the probability and severity of harm, are used in these instructions. They are defined as follows:

Signal Word	Meaning
DANGER	Indicates an imminently hazardous situation which, if not avoided, will result in death, serious injury or major property damage.
WARNING	Indicates a hazardous situation which, if not avoided, could result in serious injury, death, or major property damage.
NOTICE	Indicates special instructions that are important but not related to physical injury hazards.

Explanation of the safety pictographs

The following pictographs illustrate the type of hazard.

Pictograph	Type of Danger
	Safety Alert/General Hazard
	Explosion Risk
	Hazardous Pressure
	Flammable Fire Hazard

Identification of warnings

Warnings are intended to help you recognize risks and avoid death, injury or property damage. This is how warnings are identified:

 Signal Word
Pictographs
<p>Description of danger. Consequences if ignored.</p> <p>⇒ The arrow signals a safety precaution to be taken to eliminate or reduce the risk.</p>

Safety Label on Cyclor

Review this label before installing or operating this Cyclor. Contact King Technology at 800-222-0169 if this label is missing from your POOL FROG Cyclor.



Fire, explosion and high pressure hazards

To minimize the risk of serious injury, death or property damage while using the POOL FROG Cyclor:

- ⇒ Read, understand and follow all instructions and safety precautions in the manual, and on this Cyclor and on any label for chemicals used with this Cyclor including POOL FROG Bac Pacs, POOL FROG Mineral Reservoir and FROG BAM Algae Preventative.

DANGER

- ⇒ Never use fast dissolving chlorine tablets, liquid bleach, or calcium hypochlorite in the POOL FROG Cyclor.
- ⇒ Never mix Trichlor chlorine tablets with Calcium Hypochlorite, or with any other form of concentrated chlorine or other chemicals.
- ⇒ Never add any other types of chlorine, pH adjusters, shock treatments or algaecides through the skimmer. These products should be added directly into the pool if required.
- ⇒ Do not contaminate the POOL FROG Cyclor, POOL FROG Mineral Reservoir, POOL FROG Bac Pac or FROG BAM with dirt, organic matter, pool chemicals (such as calcium hypochlorite or pool shocks), fertilizers or other household chemicals. Contact between any of these substances and the POOL FROG Cyclor, POOL FROG Mineral Reservoir, POOL FROG Bac Pac or FROG BAM, will result in a chemical reaction with the generation of heat, liberation of hazardous gasses and fire or explosion.

WARNING

- ⇒ Use only POOL FROG Bac Pacs, POOL FROG Mineral Reservoir, and FROG BAM in the POOL FROG Cyclor. Never use bulk chemicals.
- ⇒ To prevent the build up of gas pressure in the POOL FROG Cyclor, be sure the pool return line valves are open – except when opening or servicing the unit.
- ⇒ Do not inhale fumes from the POOL FROG Cyclor or POOL FROG Bac Pac.
- ⇒ Avoid sparks, smoking, or any open flame near POOL FROG Cyclor or chemicals.
- ⇒ Do not exceed maximum operating pressure of 50 psi or maximum temperature of 104° F.
- ⇒ Do not remove the cap while under pressure. Always turn off pump and bleed off pressure before opening POOL FROG Cyclor.
- ⇒ Do not install automatic or fast shut off valves downstream of Cyclor.
- ⇒ Always install the POOL FROG Cyclor AFTER a heater (if applicable) on the return line.
- ⇒ Always install any additional sanitizing equipment AFTER and NEVER BEFORE the POOL FROG Cyclor is installed on the return line.
- ⇒ Do not permit children to use or climb on this product. This product must be positioned to prevent children from using it as a means of access to the pool.
- ⇒ Always stand clear of the POOL FROG Cyclor during pump start-up.
- ⇒ Replace POOL FROG Cyclor if you see signs of cracks, damage or degradation to the Cyclor body or cap.

NOTICE

- ⇒ Prior to pressurizing, check with your dealer to ensure your plumbing connections meet building codes.
- ⇒ Failure to properly winterize your POOL FROG Cyclor could result in freeze damage. (See page 18 for winterizing details.)

Installation Tips to Ensure Proper Performance

Before installing, read all directions carefully and contact your dealer for installation support.



WARNING

- Do not exceed maximum operating pressure of 50 psi.
- Do not install automatic or fast shut off valves downstream of feeder.
- Always install the POOL FROG Cyclor AFTER the heater (if applicable) on the return line.
- Always install any additional sanitizing equipment AFTER and NEVER BEFORE the POOL FROG Cyclor is installed on the return line.

1) If using a multi-speed pump, run pump for at least 6 hours per day at high speed (at least 40 gpm).

If the pump will run on low speed 24 hours per day or less than 6 hours per day on high speed, you must bleed the air while the pump is on by unscrewing the back knob until water appears. Then screw the knob back in. Repeat this process each time the cap is removed for any reason.



2) Install Cyclor with 4-8 psi back pressure.

Lower back pressures could result in under chlorination. Change the eyeball fittings in the return jets to a smaller size to increase back pressure. Contact King Technology at 800-222-0169 for a specially designed Cyclor pressure gauge to determine back pressure at pool start-up.



PN #01-22-4000

3) Special installation Requirements:

IMPORTANT: Over chlorination or damage to the POOL FROG Cyclor or other equipment could result if special installations A, B or C are not used in these situations.

- If water flow is higher than 80 gallons per minute (gpm), see diagram A.
- If an in-floor cleaner is included with pool, see diagram B, with two options. Preferred installation is Option 1 with two separate lines.
- If set-up is a pool and spa combination with common equipment, see diagram C.

Questions? Call Customer Service at 800-222-0169 Monday thru Friday, 8 am to 5 pm central time.

A. With High Flow Rate (greater than 80 gpm)

Install T-fittings exactly as shown.

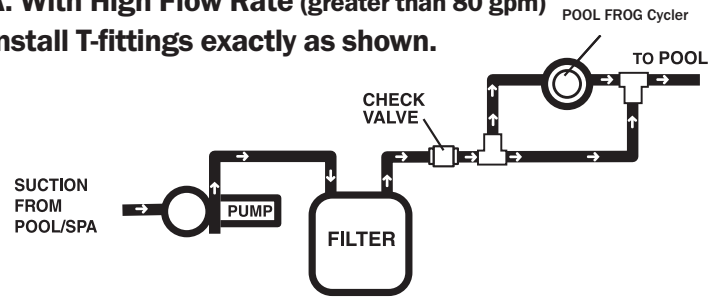

B. With In-Floor Cleaner - TWO OPTIONS

OPTION 1- A Two-Line Installation

The best option is to have two lines. One line with pump, filter, heater and POOL FROG Cyclor and a second line with a separate pump for the in-floor cleaning system (filter optional).

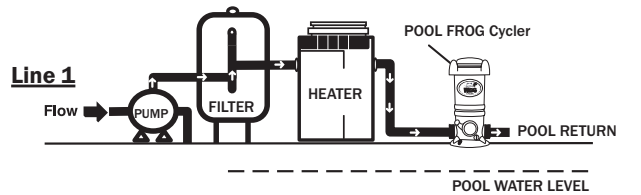

Line 2

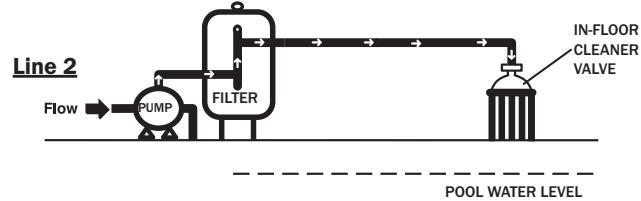

OPTION 2 - A 3-Way Valve Installation

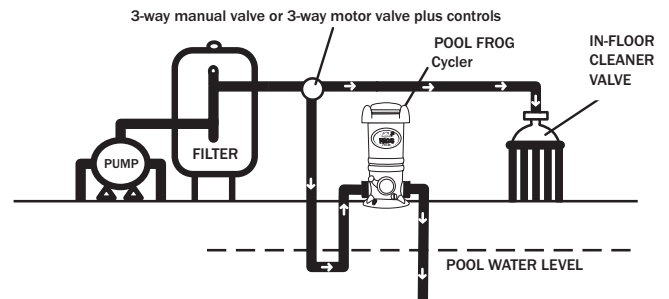

C. Pool and Spillover Spa Combination

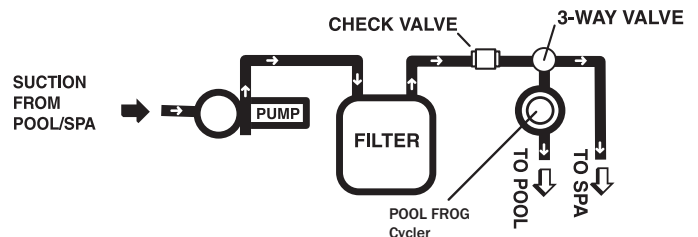

TOOLS NEEDED

Screwdriver



Pipe Wrench

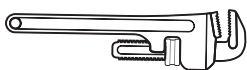

INCLUDED WITH POOL FROG CYCLER

Pipe Thread Tape or Sealant

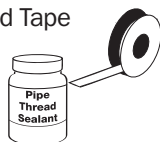

One 6" X 1 1/2" TBE PVC Nipple



MATERIALS NEEDED

One Hose Adapter
1 1/2" X 1 1/2" X 1 1/4"



One Section of
1 1/2" or 1 1/4" Flex Hose



One
Hose Clamp



RECOMMENDED

4-8 psi Back Pressure

To avoid over or under chlorination, replace eyeball fittings in the return jets to a smaller or larger size to adjust back pressure. For best results use King Technology's pressure gauge, order part number 01-22-4000.



Filter Flex-Hose Installation

1. Apply pipe thread tape or sealant to each threaded end of nipple.

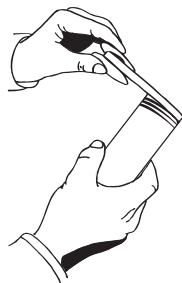

2. Screw one end of nipple into the filter return. Hand tighten. Finish tightening by turning 1 to 2 revolutions with a pipe wrench. **DO NOT OVER TIGHTEN.**

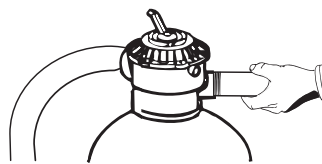

3. Screw either side of POOL FROG Cyclers on to open nipple end until upright and secure.

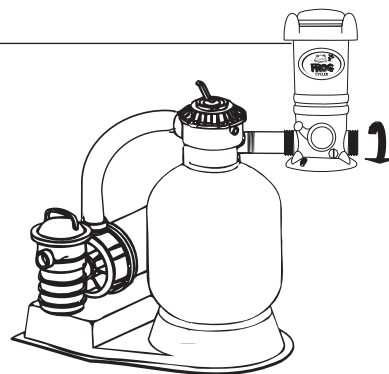

4. Apply pipe thread tape or sealant to threaded end of hose adapter.

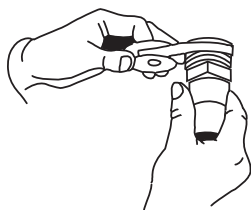

5. Screw adapter into the other side of POOL FROG Cyclers. Hand tighten. Finish tightening by turning 1 to 2 revolutions with a pipe wrench. **DO NOT OVER TIGHTEN.**

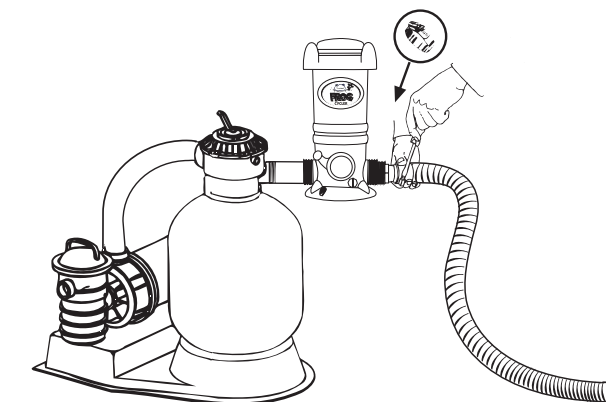
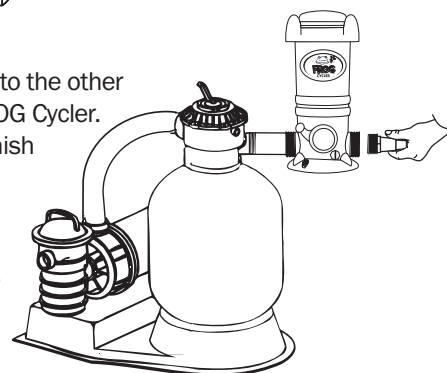
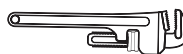

6. Attach return section of hose to the adapter with clamp. Tighten clamp with screwdriver.

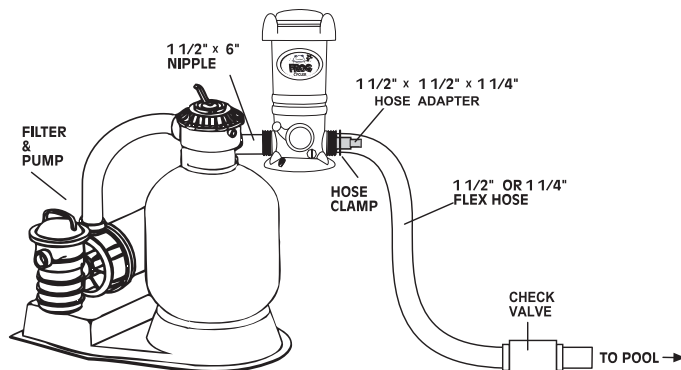

7. To prevent damage to heaters or filters, see your dealer about installing a **corrosion resistant check valve** which will reduce the back flow of chlorine gas when the Cyclers is turned off.

TOOLS NEEDED

Screwdriver

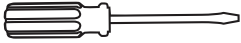

Pipe Wrench

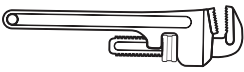

MATERIALS NEEDED

Pipe Thread
Tape
or Sealant

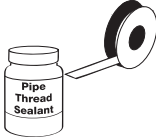

Two Hose Adapters
1 1/2" X 1 1/2" X 1 1/4"



Two Sections of 1 1/2"
or 1 1/4" Flex Hose

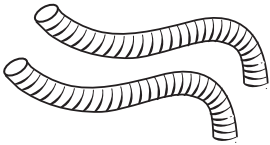

Two
Hose
Clamps



RECOMMENDED

4-8 psi Back Pressure

To avoid over or under chlorination, replace eyeball fittings in the return jets to a smaller or larger size to adjust back pressure. For best results use King Technology's pressure gauge, order part number 01-22-4000.



Base Flex-Hose Installation

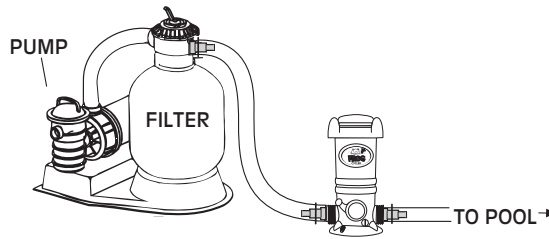

The POOL FROG Cyclor should always be installed between the filter and pool (or between heater and pool if applicable). Never install POOL FROG Cyclor before the heater or damage to the heater could occur.

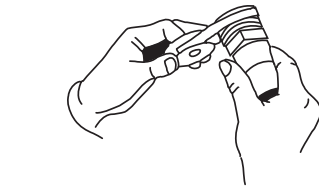

1. Apply pipe thread tape or sealant to the threaded end of both hose adapters.

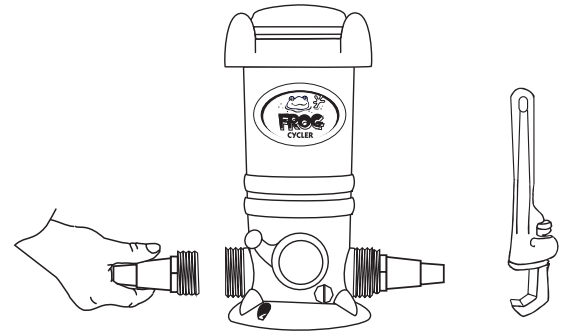

2. Screw adapters into each end of POOL FROG Cyclor. Hand tighten. Finish tightening by turning 1 to 2 revolutions with a pipe wrench. **DO NOT OVER TIGHTEN.**

3. Attach the filter section of flex hose to one hose adapter and the return section of flex hose to the other hose adapter with clamps and tighten with screwdriver. Bi-flow valve design allows water flow in either direction.

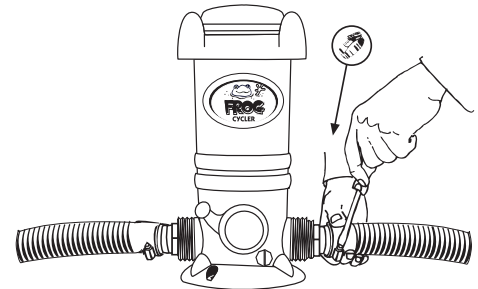

4. To prevent damage to heaters or filters, see your dealer about installing a **corrosion resistant check valve** which will reduce the back flow of chlorine gas when the Cyclor is turned off.

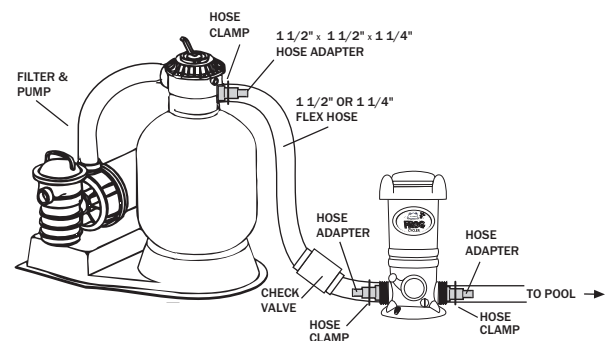

5. For better stability, POOL FROG Cyclor may be mounted on a treated wood base using **Phillips pan head screws**, one in front and two in back. If you have questions about stability, please contact your dealer or King Technology.

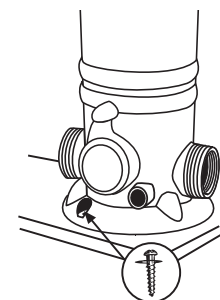

TOOLS NEEDED

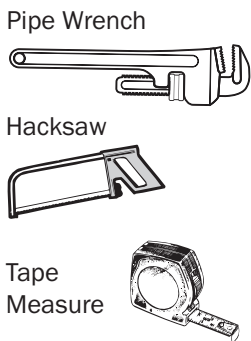

MATERIALS NEEDED

Pipe Thread Tape or Sealant, Primer and PVC Cement

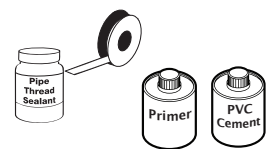

1½" Male Adapter (slip x MPT)



or

2" Female Adapter (slip x FPT)



SECURE CYCLER

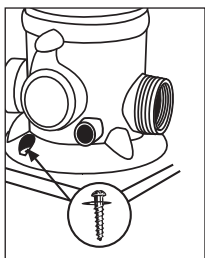

For better stability, POOL FROG Cyclers may be mounted on a treated wood base using **Phillips pan head screws**, one in front and two in back. If you have questions about stability, please contact your dealer or King Technology.

Hard-Plumbed Installation

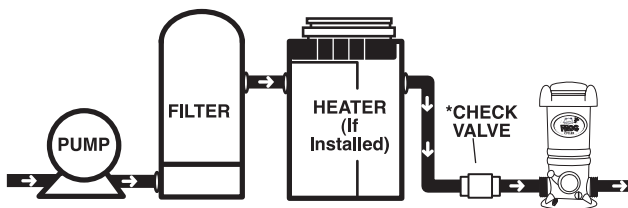

The POOL FROG Cyclers should always be installed between the filter and pool (or between heater and pool if applicable). Never install POOL FROG Cyclers before the heater or damage to the heater could occur.

Do NOT install in copper pipe if using POOL FROG Bac Pac as chemical corrosion may lead to pipe failure.

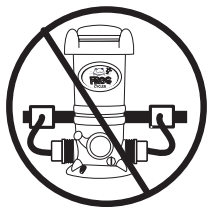

Do NOT install POOL FROG Cyclers off-line.

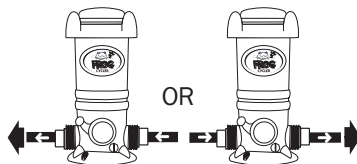

Bi-flow valve design allows installation in either flow direction.

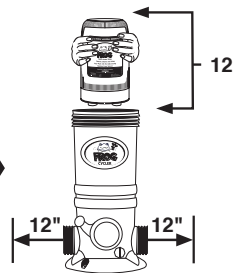

Allow a minimum of 12" above and on each side of POOL FROG Cyclers to ensure room for easy replacement of POOL FROG Mineral Reservoir and Pool FROG Bac Pac.

1. Screw adapters into each end of POOL FROG Cyclers following directions for a male adapter or a female adapter. Hand tighten. Finish tightening by turning 1 to 2 revolutions with a pipe wrench. **DO NOT OVER TIGHTEN.**

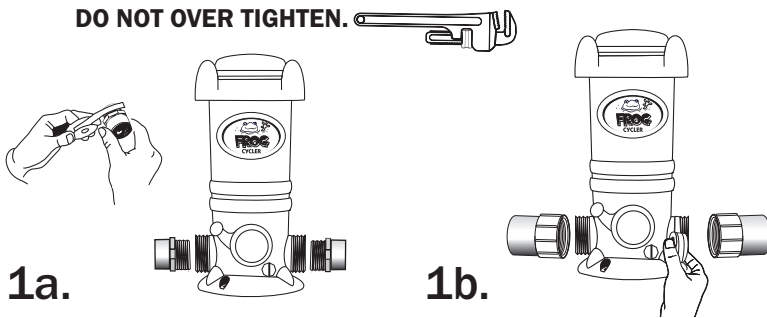

- 1a. If using **male adapters**, apply pipe thread tape or sealant to the threaded end of each adapter.

- 1b. If using **female adapters**, apply pipe thread tape or sealant to the threaded end of each feeder port.

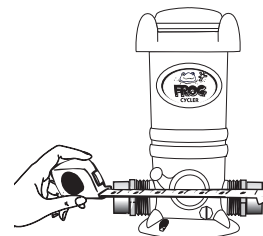

3. Following Primer directions, brush Primer on the inside of the adapters and to ends of pipe. Repeat this process with PVC cement following manufacturer's directions on that product.

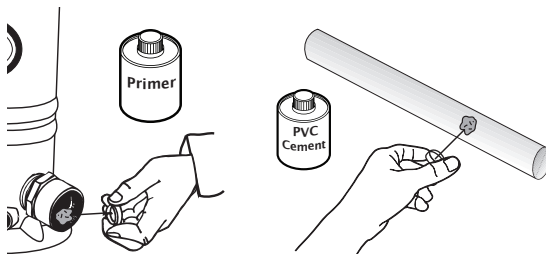

4. Insert PVC pipe into adapters with a twisting action. Hold in place 5 to 10 seconds to bond.

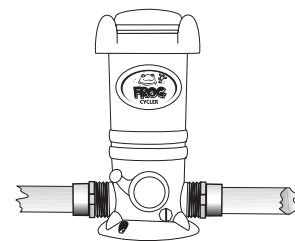

5. Final schematic diagram showing the POOL FROG Cyclers installed in the pool line between the filter and heater, with a check valve before them.

To prevent damage to heaters or filters, see your dealer about installing a **corrosion resistant check valve** which will reduce the back flow of chlorine gas when the Cyclers is turned off.

Step 1: Preparing the Pool



1. Make sure the pool has adequate circulation. The total volume of pool water must completely circulate through the pump and filter at least 1 to 2 times per day. This usually requires 8 to 12 hours of circulation. Check with your dealer for the proper circulation time for your pool.

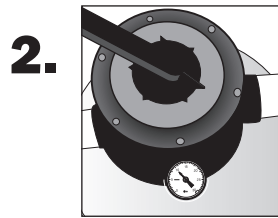

2. Check the pool's filter gauge often and periodically clean filter per the manufacturer's directions. A dirty filter will slow the flow of water which could hamper proper circulation.



WARNING

Do not exceed maximum operating pressure of 50 psi.

3. Check the Water Hardness of your fill water before adding to the pool. If calcium content is higher than 400 ppm, find a soft water source to fill your pool instead; otherwise water balance will be very difficult.

4.



Check for metals in the pool such as iron or copper. Before attempting water balance these should be removed. See your dealer for a metal out or sequesterant and follow the label directions carefully.

5.

Before beginning with any pool care program, you must first balance your pool water. Take a water sample to your local pool professional (or use a complete test kit) to test for the important Water Balance Guidelines.

IMPORTANT: Always follow printed instructions on the balancing chemical packages. Add balancing chemicals in small increments, one at a time, with circulation running. **For best results, wait 8-12 hours** before testing again and adding any additional balancing chemicals.

Water Balance Guidelines

pH:	7.2 – 7.8
Total Alkalinity:	80 – 120 ppm
Calcium Hardness:	200 – 400
Total Dissolved Solids:	<1500
Stabilizer:	20 – 80 ppm
Free Chlorine:	0.5 – 1.0 ppm

Continue... Step 1: Preparing the Pool

For best results in achieving water balance, follow steps **5a through 5e** in order.

5a. Take a water sample from the pool and dip a FROG Test Strip into it.



5b. Look at the **Total Alkalinity** reading first. Adjustments should be made to bring the Total Alkalinity in the range of **80 – 120 ppm** prior to making any adjustments to pH even if it throws pH off further.

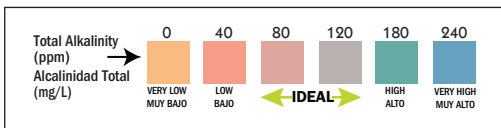

5c. After **Total Alkalinity** is in range, test for **pH**. It should be between **7.2 and 7.8**. If higher or lower, add a pH adjuster.

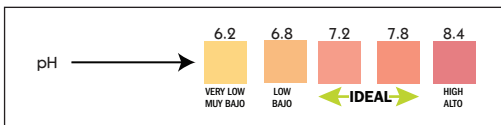

5d. Then test your Water Hardness again. If lower than 200 ppm, add Calcium Increaser. Always maintain 200-400 ppm.

5e. Lastly, test for **stabilizer** or **conditioner** levels. Add conditioner if the level is below 20 ppm. This will prevent chlorine burn off. If stabilizer level is above 80 ppm, partially drain water and re-fill.

6. Initially shock the pool with a **chlorine shock only** to rid the water of contaminants and establish a chlorine residual. Always follow the manufacturer's directions carefully. See the DANGER box below for important guidance on shocking.



DANGER

- Never add any other types of chlorine, pH adjusters, shock treatments or algaecides through the skimmer. These products should be added directly into the pool if required.
- Never use fast dissolving chlorine tablets, liquid bleach, or calcium hypochlorite in the POOL FROG Cyclor.

Step 2: Putting the System to Work

1.



Install a POOL FROG Mineral Reservoir into the POOL FROG Cyclor. (See page 15 for directions.)

IMPORTANT:

Replace the POOL FROG Mineral Reservoir every 6 months or after one pool season, whichever is shorter. After that time, you will hear the spent media inside, however it is no longer effective and must be replaced.

2.



Replace cap and run POOL FROG Cyclor, with POOL FROG Mineral Reservoir inserted, for 10 minutes on Setting 10.

3.



Insert FROG BAM into the open center of the POOL FROG Mineral Reservoir in the POOL FROG Cyclor. (See page 16 for directions.)



4.

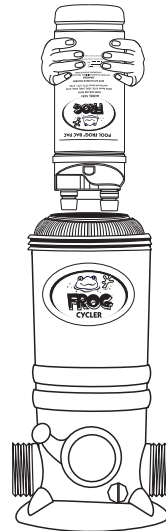

When chlorine reading is down to 1.0 ppm, which may take a few days, insert POOL FROG Bac Pac into the open center of the POOL FROG Mineral Reservoir. (See page 17 for directions.)

Step 3: Setting the Control Dial

1. This Cycler is designed to work effectively with a variety of pool equipment as long as the following procedures are followed. Set the control dial by matching up the parameters of your pool on the chart below. THIS IS A STARTING POINT ONLY and may need to be adjusted to fit your individual pool needs. See #2 for adjusting directions. **IMPORTANT:** If using a multi-speed pump, pump-run times of at least 6 hours per day at high speed are recommended for proper performance.

If running the pump at low speed only or on high speed less than 6 hours, please follow the 24 hour low-speed directions below.

POOL SIZE Gallons Diameter		8 HOUR PUMP RUN TIME				12 HOUR PUMP RUN TIME				24 HOUR PUMP RUN TIME			
		PUMP SIZE				PUMP SIZE				PUMP SIZE			
		1/2 hp	3/4 hp	1 hp	1 1/2 hp	1/2 hp	3/4 hp	1 hp	1 1/2 hp	1/2 hp	3/4 hp	1 hp	1 1/2 hp
7,000	(18')	5.0	4.5	4.0	3.5	4.5	4.0	3.0	5.0 [^]	3.5	3.0	2.5	4.0 [^]
9,000	(21')	5.5	5.0	4.5	4.0	5.0	4.5	4.0	5.5 [^]	4.0	3.5	3.0	4.5 [^]
12,000	(24')	6.0	5.5	5.0	4.5	5.5	5.0	4.5	4.0	4.5	4.0	3.5	5.0 [^]
15,000		NR	6.0	5.5	5.0	6.0	5.5	5.0	4.5	5.0	4.5	4.0	3.5
20,000		NR	NR	6.0	5.5	NR	6.0	5.5	5.0	5.5	5.0	4.5	4.0
25,000		NR	NR	6.5	6.0	NR	6.5	6.0	5.5	6.0	5.5	5.0	4.5

[^] - Bypass installation recommended. See "Installation Tips" on page 6. NR - This pump size is not recommended for this size pool. RECOMMENDED FLOW RATE: 20-60 gpm

24 HOUR, LOW-SPEED PUMP-RUN TIME

In order to ensure proper performance when running the pump on low speed for 24 hours per day or high speed less than 6 hours per day, bleed the air while the pump is on by unscrewing the knob on the back of the Cycler near the cap until water appears. Then screw the knob back on. Repeat this process each time the cap is removed for any reason. Set the control dial at 6 and follow the adjustment directions below to determine the correct setting for your pool.

EXAMPLE

POOL SIZE Gallons Diameter		12 HOUR PUMP RUN TIME			
		PUMP SIZE			
		1/2 hp	3/4 hp	1 hp	1 1/2 hp
7,000	(18')	4.5	4.0	3.0	5.0 [^]
9,000	(21')	5.0	4.5	4.0	5.5 [^]
12,000	(24')	5.5	5.0	4.5	4.0
15,000		6.0	5.5	5.0	4.5
20,000		NR	6.0	5.5	5.0
25,000		NR	6.5	6.0	5.5

Find your starting dial setting by matching up the parameters of your pool on the above chart. An above ground pool with approximately 12,000 gallons, with a 1 horsepower pump running 12 hours a day, would require a starting setting of 4.5.



2. For the first week, test the pool water daily for free chlorine with FROG Test Strips to ensure correct dial setting. Continue to test weekly throughout the season.



After each testing, adjust the dial up by 1/2 increment if the free chlorine reading has dropped below 0.5 ppm or adjust down by 1/2 increment if the reading has risen above 1.0 ppm. Continue this process each day until the free chlorine reading stabilizes to at least 0.5 ppm.

IMPORTANT: Control dial settings in excess of these recommendations could result in excess trichlor levels being discharged into the pool. This can result in bleaching or discoloration of areas around the pool inlet or, in some cases, bleaching or discoloration of the entire pool liner or paint. In addition, excess trichlor in the pool can create health hazards to bathers.

Remember to adjust dial by 1/2 increments only in order to prevent over chlorination which may bleach pool surfaces.

Step 4: Routine Pool Care



1. Run filtration enough hours to circulate all water 1 to 2 times per day. More than that could result in over chlorination.



WARNING

To prevent the build up of gas pressure in the **POOL FROG Cyclor**, be sure the pool return line valves are open –except when opening or servicing the unit.



2. Regularly test water with FROG Test Strips to maintain pH and Total Alkalinity.

NOTE: Water balance is affected by bather load, chemical usage, evaporation and the makeup of source water, so maintaining water balance regularly is important.



3. Maintain 0.5 to 1.0 ppm free chlorine level at all times.

Note: These lower chlorine levels are only acceptable when using FROG minerals.



DANGER

Do not contaminate the **POOL FROG Cyclor**, **POOL FROG Mineral Reservoir**, **POOL FROG Bac Pac** or **FROG BAM** with dirt, organic matter, pool chemicals (such as calcium hypochlorite or pool shocks), fertilizers or other household chemicals. Contact between any of these substances and the **POOL FROG Cyclor**, **POOL FROG Mineral Reservoir**, **POOL FROG Bac Pac** or **FROG BAM**, will result in a chemical reaction with the generation of heat, liberation of hazardous gasses and fire or explosion.

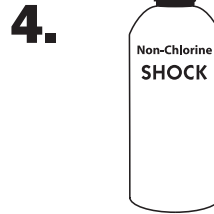

4. Shock the pool every other week or as needed. We recommend a non-chlorine shock as reducing chlorine use is the goal of FROG products. However, using a chlorine shock is OK too.



DANGER

- Never add any other types of chlorine, pH adjusters, shock treatments or algaecides through the skimmer. These products should be added directly into the pool if required.
- Never use fast dissolving chlorine tablets, liquid bleach, or calcium hypochlorite in the **POOL FROG Cyclor**.



5. Before closing the pool for winter, use FROG BAM following the directions on page 16.



6. Remember to replace **POOL FROG Mineral Reservoir** and all other **POOL FROG** replacements as directed.

Replacing a POOL FROG Mineral Reservoir

Must be replaced every 6 months or after one pool season.



1.

POOL FROG® MINERAL RESERVOIR

The Complete Low-Chlorine Alternative®
www.FrogProducts.com • 800-222-0169

Serial No. _____ Series 6100 (01-12-6112)
FOR POOLS UP TO 25,000 GALLONS

Product Description: The POOL FROG Mineral Reservoir is the heart of an advanced pool care system that destroys bacteria. The patented mineral formula in the POOL FROG Mineral Reservoir also neutralizes acids, which helps keep the pH in an acceptable range with less monitoring. The controlled release of minerals provides an optimum level of protection in your pool. The FROG Mineral System™ reduces chlorine use up to 50%*. Simply use with at least 0.5 ppm of an EPA registered source of chlorine such as the POOL FROG Bac Pac (EPA Reg. No. 53735-2) or a chlorine delivery device. Using the POOL

Check the top of the box and back label of product to make sure you have the correct POOL FROG Mineral Reservoir to fit your POOL FROG Cycler.

IMPORTANT: The POOL FROG Mineral Reservoir must be replaced every 6 months or after one pool season, whichever is shorter.

2.



IMPORTANT: Remove and read the information card.

Please note: Complete instructions for inserting a POOL FROG Mineral Reservoir, FROG BAM and POOL FROG Bac Pac are included inside the POOL FROG Mineral Reservoir.



DANGER

- Never use fast dissolving chlorine tablets, liquid bleach, or calcium hypochlorite in the POOL FROG Cycler.

3.

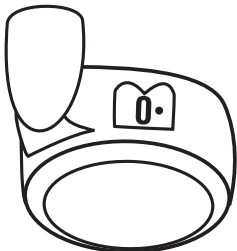

Turn off pump and turn control dial to Setting 0. This reduces the flow of water into the unit when the cap is open.

4.



Open POOL FROG Cycler cap.

5.

Remove the POOL FROG Bac Pac and if not empty, set to the side or store for winter. Then remove the POOL FROG Mineral Reservoir and discard if it has been used for one pool season or 6 months, whichever is shorter.

6.

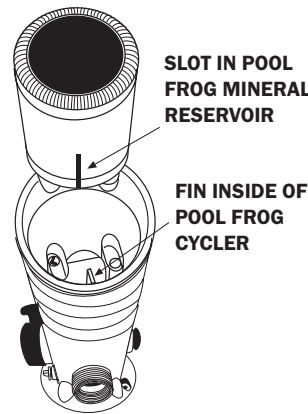

Find slot on side of POOL FROG Mineral Reservoir and line up with fin inside the POOL FROG Cycler. Lower POOL FROG Mineral Reservoir into POOL FROG Cycler until secure.

Replace the POOL FROG Bac Pac inside the POOL FROG Mineral Reservoir to continue operating system (see directions on page 17)

7.



Mark your calendar ahead for the six month replacement of the POOL FROG Mineral Reservoir. **Once wetted, the time-released mineral coating of this product is effective up to 6 consecutive months or one pool season, whichever is shorter. After that time you will hear the spent media inside, however, it is no longer effective and must be replaced.**

Using FROG BAM for an Algae-Protection Guarantee

If you are not using FROG BAM, refer to page 17 for Using the POOL FROG Bac Pac. See FROG BAM product labeling for complete directions for use (EPA Reg. No. 53735-9).

For a preventive dose add:

- One FROG BAM for pools up to 15,000 gallons.
- Two FROG BAM for pools between 15,000 and 30,000 gallons.

NOTE: If using directly after a shock treatment, test the water first to ensure the pH is in the proper range of 7.2-7.8 and the chlorine level is no more than 4.0 ppm. Avoid using other chemicals until this product has been circulated (filtered) for at least 24 hours.



DANGER
Never use fast dissolving chlorine tablets, liquid bleach, or calcium hypochlorite in the POOL FROG Cyclor.

Important: If storing FROG BAM prior to use, always keep in a cool, dry place away from children and pets.

1.  Remove cap from FROG BAM without removing seal.

Turn off pump. Turn control dial to 0. Open Cyclor cap. Stand back to let any chlorine fumes dissipate.

2.  Insert upside down into the open center of the POOL FROG Mineral Reservoir pushing down firmly on FROG BAM bottle allowing key in POOL FROG Cyclor to puncture seal.

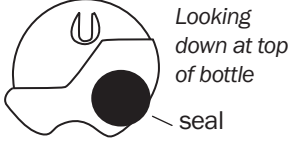

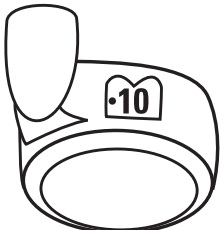

Looking down at top of bottle
seal

3.  Replace cap by hand only. **DO NOT OVER TIGHTEN.**

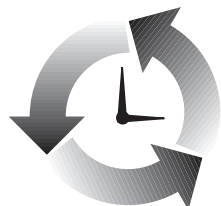
4.  Turn control dial on to Setting 10.

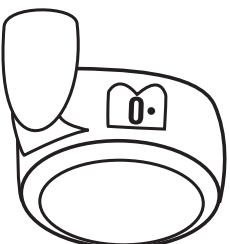
5.  Turn pump on for 90 minutes allowing FROG BAM to circulate through pool.

6.  To remove expended FROG BAM bottle, turn pump off and turn dial to Setting 0.

7.  Remove POOL FROG Cyclor cap.

8.  Lift FROG BAM up and allow any water in the container to drain through the POOL FROG Cyclor before discarding in trash or offering for recycling. Do not reuse or refill this container.

NOTE: If water shows more than a hint of blue inside POOL FROG Cyclor, replace the POOL FROG Cyclor cap, turn dial to Setting 10 and run the pump for one minute.

8a. If pool size requires additional FROG BAM, repeat steps 1-8.

8b. When water is clear in the POOL FROG Cyclor, insert a POOL FROG Bac Pac according to the instructions on page 17.

Using the POOL FROG Bac Pac



POOL FROG Bac Pac is required to assure up to 50% reduction in chlorine use*. POOL FROG Bac Pac sold separately. (EPA Reg. No. 53735-2)



DANGER

Never use fast dissolving chlorine tablets, liquid bleach, or calcium hypochlorite in the POOL FROG Cycler.



WARNING

Avoid sparks, smoking, or any open flame near POOL FROG Cycler or chemicals.

IMPORTANT: Read the label on the POOL FROG Bac Pac carefully before using.



1.

Turn pump off. Turn control dial to 0.

Remove cap from POOL FROG Cycler and stand back to let any chlorine fumes dissipate.



2.

Colored Caps

Remove colored caps by grabbing on to the lip of one cap with a pliers and pulling up until cap releases. Repeat the process for the other cap.

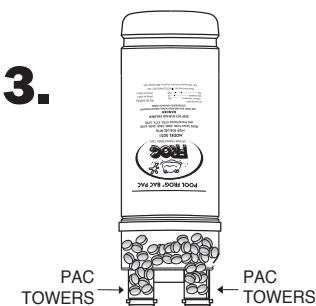

3.

Invert POOL FROG Bac Pac and shake slightly until chlorine tablets fall into tower areas.

PAC TOWERS PAC TOWERS

4.

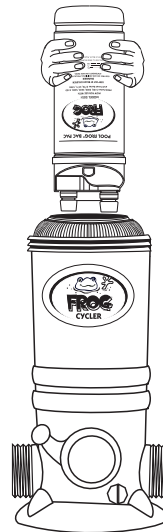

Line up the small leg of the POOL FROG Bac Pac with the small opening in the POOL FROG Mineral Reservoir and the large leg with the large opening. Lower POOL FROG Bac Pac into POOL FROG Mineral Reservoir until secure.

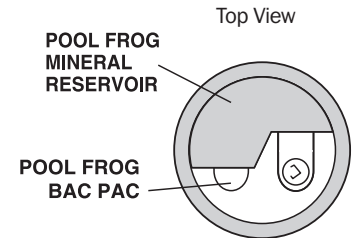

Top View

POOL FROG MINERAL RESERVOIR

POOL FROG BAC PAC

5.



Replace cap by hand only. **DO NOT OVER TIGHTEN.**

6.



The chlorine pac container is made of HDPE plastic. Non-refillable container. Do not reuse or refill this container. Offer for recycling if available. Rinse thoroughly before recycling or discarding in trash.

7.



Mark your calendar ahead for the approximate replacement times for the POOL FROG Bac Pac.

Winterizing

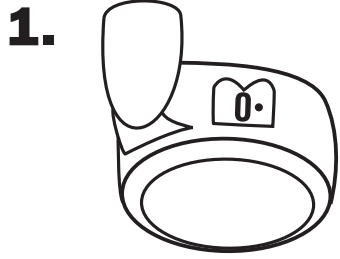

1. Turn pump off and turn dial to Setting 0.



Remove cap.

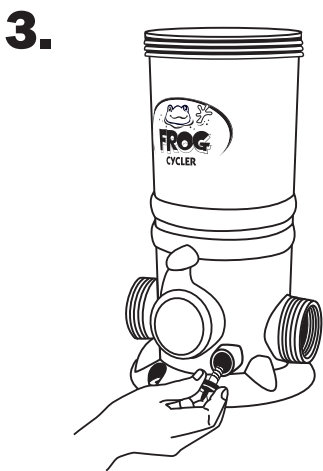

Unscrew knob from the front of POOL FROG Cycler. Allow all water to drain.



If POOL FROG Bac Pac still contains chlorine, wrap in plastic bag and store in shed or cool, dry, well-ventilated location away from children, pets, cars, motorcycles or anything metal that can rust, pit, etc.

If empty, rinse and recycle.



WARNING

Avoid sparks, smoking, or any open flame near POOL FROG Cycler or chemicals.

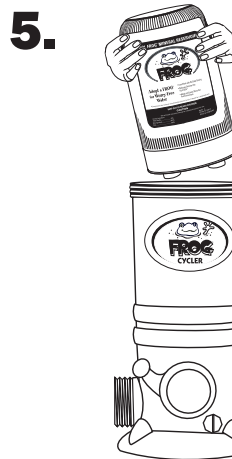

Remove the POOL FROG Mineral Reservoir and discard in trash. You will hear spent media inside, however, it is no longer effective.



Replace the cap and knob loosely.

Troubleshooting

For more in-depth troubleshooting, go to frogproducts.com or call King Technology at 800-222-0169.

Problem	Remedy		
<p>1. What do I do if the water looks cloudy?</p>	<p>1. Make sure your filtration system is working properly (i.e. clean filter, skimmer and pump basket).</p> <p>2. Make sure circulation time is adequate – increase pump</p>	<p>time if not.</p> <p>3. Make sure the pool is properly balanced. (See page 10.)</p> <p>4. Shock the water to eliminate build up of any organic matter.</p>	<p>5. Make sure pool has a free chlorine reading of 0.5 to 1.0 ppm.</p> <p>6. Check with your dealer for more information.</p>
<p>2. What do I do if the water turns color?</p>	<p>1. Algae may be trying to form – shock the pool, increase circulation time if needed and clean the filter.</p>	<p>2. Metals in the fill water may have been oxidized. Have the pool tested. See pool dealer if a metal control product is required.</p>	<p>3. Check with your dealer for more information.</p>
<p>3. What do I do if algae forms in or on my pool?</p>	<p>1. Use FROG BAM or an effective algaecide per the directions on the bottle and brush the sides of the pool often.</p> <p>2. Clean the filter and shock the pool with chlorine daily until</p>	<p>water clarity returns.</p> <p>3. If you are in an area of the country that struggles with algae growth, see your dealer regarding a 90-day Algae Protection Guarantee using</p>	<p>FROG BAM. See product hang tag for guarantee details.</p> <p>4. Check with your dealer for more information.</p>
<p>4. What do I do if I am under chlorinating with the POOL FROG Bac Pac?</p>	<p>1. If you are unable to maintain 0.5 to 1.0 ppm, first make sure there are chlorine tablets in the tower areas of the POOL FROG Bac Pac and it is installed properly. If a correction was made, test the water in 24 hours.</p> <p>2. If still low, turn the dial up one setting and test the water again in 24 hours. Continue raising the setting by one increment each day until the</p>	<p>proper reading is achieved.</p> <p>3. Shock the pool if the reading has been lower than 0.5 ppm for more than one day.</p> <p>4. Make sure pump run time is at least 6 hours on high speed (40 gpm or higher) or if not, bleed the air from the back knob each time cap is open.</p> <p>5. Contact your dealer to have your back pressure tested. If under 4 psi consider a smaller</p>	<p>eyeball fitting in the return jet.</p> <p>6. Check for a suction side leak by looking for air bubbles in your pump basket or at the return jet. Contact dealer for help in correcting this situation.</p> <p>7. Contact King Technology's Customer Service Department at 800-222-0169.</p>
<p>5. What do I do if I am over chlorinating with the POOL FROG Bac Pac?</p>	<p>1. If the chlorine reading is over 3.0 ppm, remove the POOL FROG Bac Pac from the POOL FROG Mineral Reservoir and test the water daily until the reading is down to 1.0 ppm.</p> <p>2. Reinsert the POOL FROG Bac Pac, lower the dial one setting and test the water again in 24 hours. If the reading has risen, lower the dial one setting again. Continue this process until proper reading is achieved.</p>	<p>3. If over-chlorinating at the lowest possible setting, consider decreasing the circulation time. Depending on your pump size, you may be circulating the water more than is necessary.</p> <p>4. Contact your dealer to have your back pressure tested. If over 8 psi consider a larger eyeball fitting in the return jet.</p>	<p>5. Check to see if the pressure relief valve is loose or missing and replace. It is a clear plastic piece approximately 1" long installed inside near the base. If loose or missing, it can provide another avenue for water to reach the chlorine.</p> <p>6. Contact King Technology's Customer Service Department at 800-222-0169.</p>

Parts List Model 6100

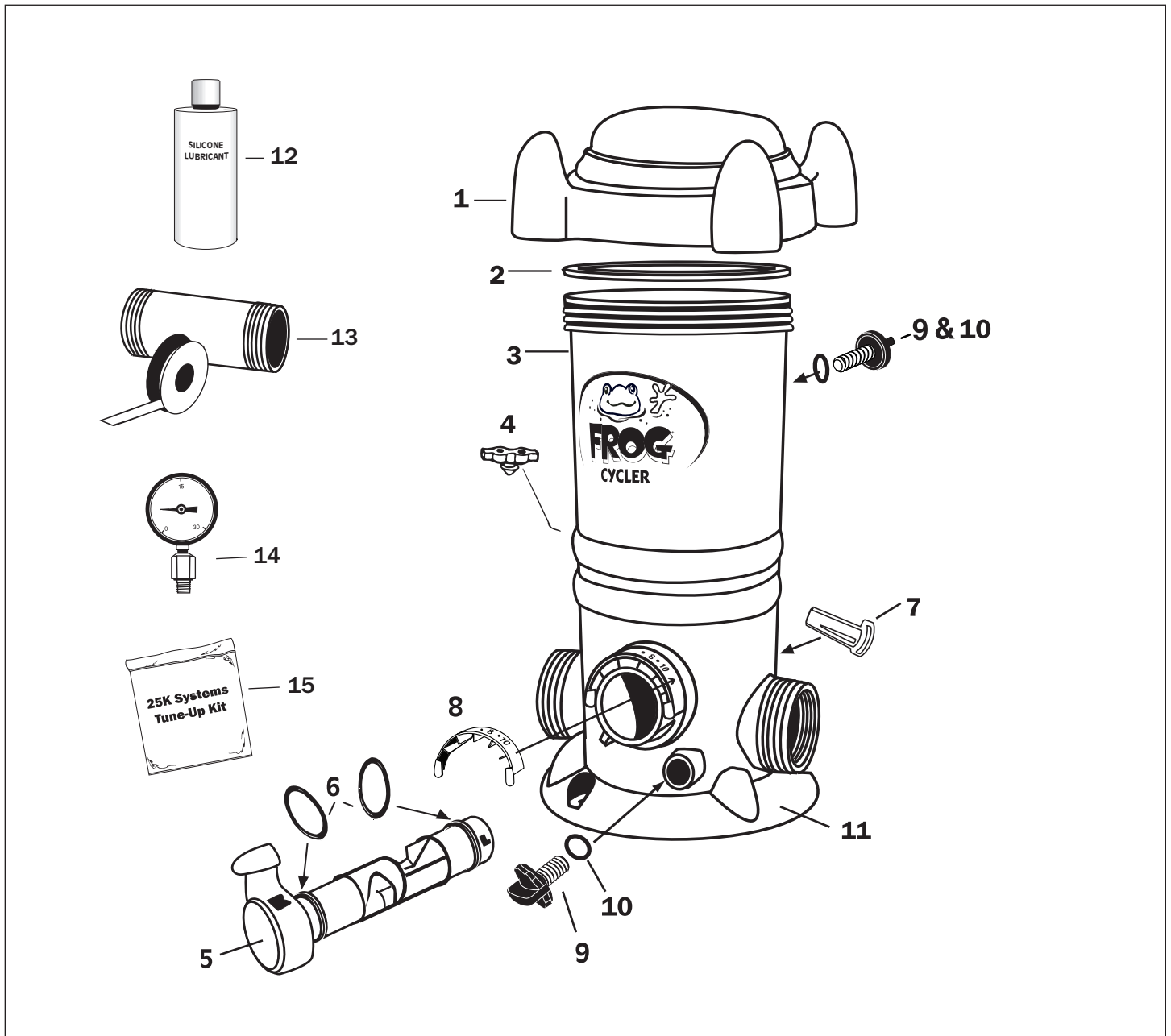

Included with POOL FROG Cyclor 6100

REF. #	DESCRIPTION	QTY. INCLUDED
1 & 2	Cap w/O-Ring	1
3	Body	1
4	Pressure Relief Valve	1
5, 6, 7, 8	Control Dial with O-Rings, Locking Pin and Number Plate	1
9 & 10	Knob with O-Ring	2
11	Mounting Base	1
12	Silicone Lubricant	1
13	Nipple Kit	1

Replacement parts for POOL FROG Cyclor 6100

REF. #	PART NO.	DESCRIPTION
1 & 2	01-22-1417	Cap w/O-Ring
2	01-22-1926	Cap O-Ring
4	01-22-9486	Pressure Relief Valve
5, 6, 7, 8	01-22-1458	Control Dial with O-Rings, Locking Pin and Number Plate
6	01-22-1456	Control Dial O-Ring Set
9 & 10	01-22-9628	Knob with O-Ring
11	01-22-1480	Mounting Base
12	01-22-9970	Silicone Lubricant 3/4 oz.
13	01-22-1710	Nipple Kit
14	01-22-4000	Pressure Gauge
15	01-22-1470	25k Tune-Up Kit

POOL FROG Cyclers Maintenance

Replacing the Control Dial O-Rings

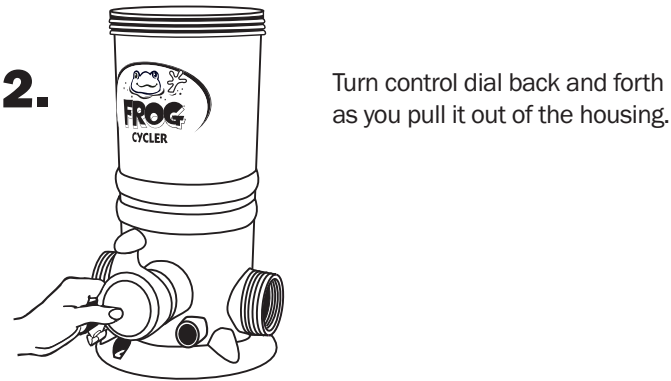
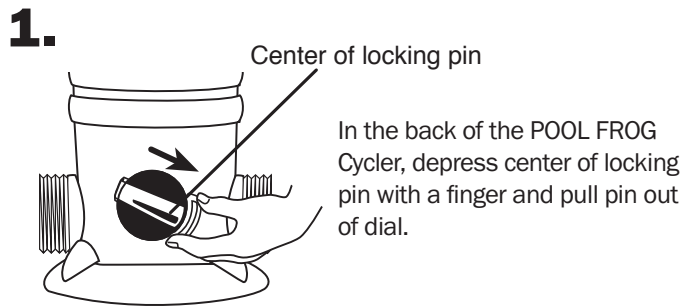

Product # 01-22-9970

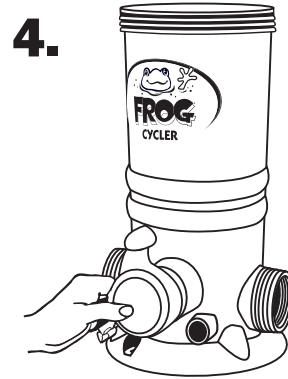

Carefully insert control dial back into housing.

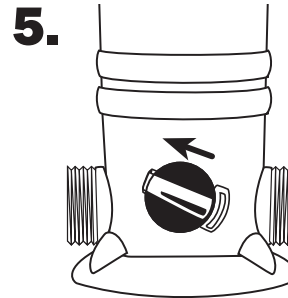

Replace locking pin by pushing it through the slots on the dial until it locks into place.

continued... POOL FROG Cycler Maintenance

Replacing the Cap O-Ring

1. Remove old O-ring.

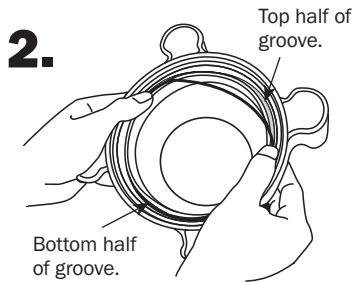

Place new O-ring in bottom half of groove.

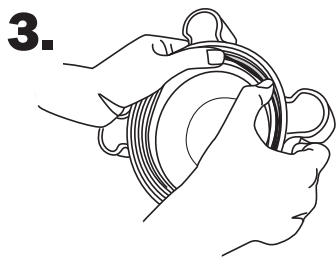

Place your thumbs on each side of the cap over the O-ring in the groove.

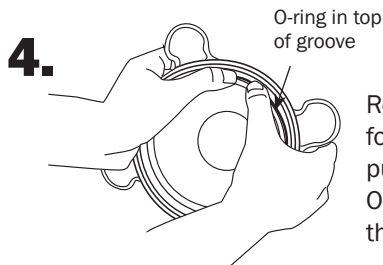

Roll your thumbs back and forth over the O-ring while pushing upward until the O-ring falls into the top of the groove.

5.



Product # 01-22-9970

Lubricate O-ring every couple of months with silicone lubricant that came with your POOL FROG Cycler.

DO NOT USE petroleum based lubricants.

Replacing Knobs

To replace, simply unscrew old knob and replace with the new one.

1.

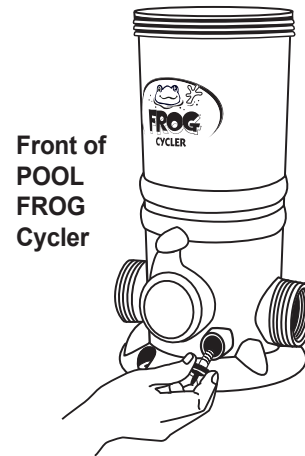

2.

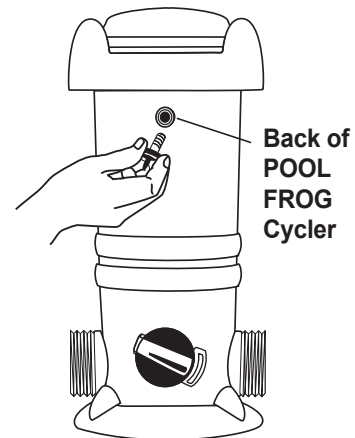

POOL FROG Cyclor Two-Year Limited Warranty

Register your warranty today at frogproducts.com/reg and extend the standard 2-year warranty to 10 years of coverage.

King Technology, Inc. will warrant this unit with a complete replacement for the original purchaser, should it prove defective by reason of improper workmanship and/or material for a period of two (2) years from the date of original purchase/installation. This warranty covers body, cap and control dial excluding O-rings. King Technology holds the option of replacing any defective part without charge if it is determined to be all that is needed to correct any situation. Parts used for replacement, with the exception of O-rings, are warranted for the remainder of the original warranty.

1. To obtain warranty service, you must deliver product to King Technology or its nearest authorized dealer. Shipping expenses are the purchaser's responsibility. The name of the nearest authorized dealer can be obtained at frogproducts.com/find-a-dealer or by calling King Technology at 1-800-222-0169. Proof of purchase is required when requesting warranty service. Purchaser must present the sales receipt or other document which establishes proof of purchase.

2. This warranty does not cover defects caused by: modification, alteration, repair or service of the product contrary to the accompanying instructions; physical abuse to or misuse of the product or operation or installation in a manner contrary to the accompanying instructions. This warranty also excludes all costs arising from the installation, adjustment, removal or replacement of defective units or parts. This warranty also excludes any and all claims arising out of the chemicals used in the product or their characteristics.

3. Any express warranty not provided for herein, and any remedy for breach of warranty or breach of contract which, but for this provision, might arise by implication or operation of law, is hereby expressly excluded and disclaimed. The implied warranties of merchantability and of fitness for any particular purpose are expressly limited to a term of two years. Some states do not allow limitation on how long an implied warranty lasts, so the above limitation may not apply to you.

4. Under no circumstance shall King Technology be liable to purchaser or any other person for any damage or loss incurred because of any chemicals used in the product or their physical characteristics, or interruption of service of the product, or any special, incidental or consequential damages or losses, whether arising out of breach of warranty, breach of contract or otherwise. Some states do not allow the exclusion or limitation of incidental consequential damages, so the above limitation or exclusion may not apply to you.

5. Misuse or failure to use the proper POOL FROG Mineral Reservoir and Bac Pac may cause damage to equipment or personal injury. All warranty null and void if this product is not used with the recommended POOL FROG Mineral Reservoir and Bac Pac.

Don't forget to register your warranty and sign up to receive emails on special offers and helpful water care tips. Visit frogproducts.com/reg

MANUFACTURED BY



© King Technology. The following are trademarks of King Technology

FROG®	FROG BAM®	SmartChlor®
POOL FROG®	FROG Serene™	FROG Jump Start®
POOL FROG XL PRO®	FROG Filter Mate™	Fresh Mineral Water®
Flippin' FROG®	INSTANT FROG®	New Water®
Flippin' FROG XL®	FROG @ease®	Perform-Max

530 11TH AVE S, HOPKINS, MN 55343 | 800.222.0169 | frogproducts.com